



OIL & GAS

World leaders in valve integrity

Innovating for tomorrow



RS Clare & Co Ltd

Innovation since 1748



RS CLARE HAS OVER TWO DECADES OF EXPERIENCE IN DEVELOPING THE MOST ADVANCED LUBRICATION AND SEALING SOLUTIONS FOR UPSTREAM VALVES.

The selection of the correct high-performance grease is proven to significantly influence the sustained integrity of API 6A gate valves.

We work in technical partnerships to solve our customers' problems and help them reduce their operational costs with the most innovative lubrication products available on the market.

ADVANCED VALVE LUBRICANTS

Our Premium valve lubricant range has been comprehensively proven to deliver increased integrity and valve functionality.

- Developed in conjunction with valve OEMs, international E&P operators and NOCs
- Extensive lab R&D and full scale valve testing
- Backed by critical field trials.



VALVE LUBRICANT KEY FUNCTIONS

- Provide an integral lubricating film between the gate and seat and the threaded stem
- Withstand the high interfacial contact stress between gate and seat surfaces
- Displace corrosive chemicals and fluids from the valve cavity
- Provide a barrier to prevent further ingress of contaminants, especially sand
- Provide additional corrosion protection to the 'exposed' internal valve components



REGAIN AND MAINTAIN VALVE INTEGRITY

INNOVATIVE VALVE LUBRICANTS
FOR A COST EFFECTIVE OPERATION

PREVENTATIVE MAINTENANCE

Fully resistant to produced hydrocarbons and other aggressive chemicals, our lubricants will not be dissolved and displaced from the valve cavity. Components will remain protected from damage and wear, and the ingress of contaminants such as sand will be prevented.

CORRECTIVE MAINTENANCE

Through decades of carefully monitored use in the field, RS Clare's valve lubricants have been proven to seal leaking gate valves for sustained periods, where other valve lubricants have been unsuccessful.



Hydrogen sulphide/
Carbon dioxide
resistant



Condensates
and other
hydrocarbon
solvents
resistant



Crude Oil
resistant



Natural Gas
resistant

WELL INTEGRITY STARTS WITH VALVE LUBRICANT 601

PROVEN TO MAINTAIN VALVE INTEGRITY IN THE WORLD'S MOST DEMANDING ENVIRONMENTS

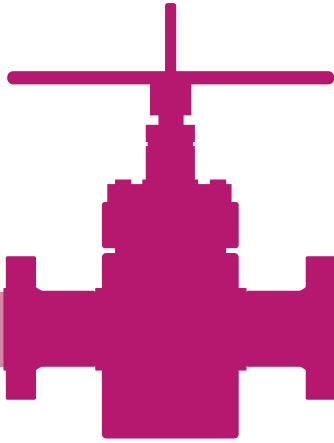

ONE OF THE INDUSTRY'S MOST SUCCESSFUL AND WIDELY USED VALVE LUBRICANT RANGES. DESIGNED FOR EXCEPTIONAL PERFORMANCE IN THE WIDEST RANGE OF OPERATING CONDITIONS.

Integrity has been restored to leaking valves in 65-75% of cases through the injection of Valve Lubricant 601.

Fully adopting Valve Lubricant 601 for preventative maintenance will deliver exponential cost saving in terms of:

- **Increased component life - reduced spare parts requirement**
- **Fewer unplanned maintenance interventions**
- **Reduced non-production time (NPT).**

Furthermore, standardising on Valve Lubricant 601 across your production operations will deliver a return on investment in as little as 18 months on the grease expenditure alone. Clients have been able to extend re-lubrication intervals, creating considerable savings on manpower and service contracts.

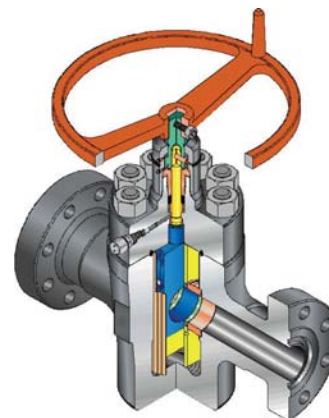
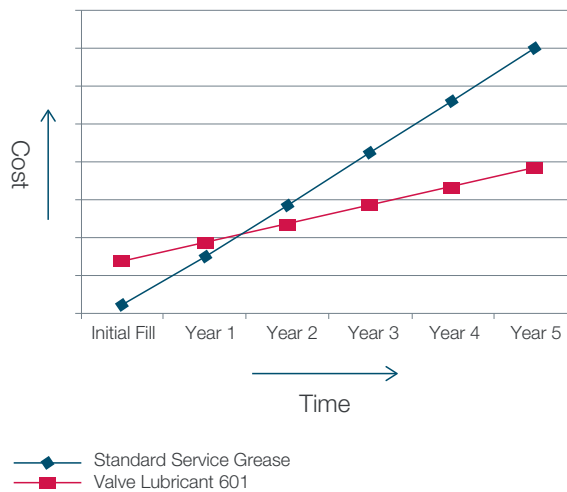

“ I would have no hesitation in recommending the use of this product on any of the wellhead configurations you have. ”

**Senior Well Integrity Engineer,
Talisman Energy**

Product	Temperature Range °F	Minimum Pumpable Temperature °F
Valve Lubricant 601	-20 to 450	-13
Valve Lubricant 601 WG	-40 to 300	-25
Valve Lubricant 601 WGX	-50 to 300	-40

**Pumpability temperatures refer to reasonable flow rates when using the RS Clare configured Alemite 70:1 Pump

REDUCE OPERATIONAL COSTS WITH VALVE SEALANT 701

FIELD PROVEN FOR THE EMERGENCY ISOLATION OF LEAKING GATE VALVES

The Valve Sealant 701 range is designed to further expand on the sealing performance achieved with Valve Lubricant 601. Gate valves leak when there is damage across the sealing surfaces of the gate or seats, in the form of galling, scoring or cutting. Boasting full resistance to produced fluids and gases and excellent lubricity, this non-hardening sealant will ensure the valve will still operate even under high DP.

GUARANTEED TO REDUCE THE OPERATIONAL COSTS ASSOCIATED WITH LEAKING VALVES.

Valve Sealant 701 is able to seal gate valves which have more severe damage on the gate and seats. This performance has been proven both in the pressure test workshop, by using purposely cut seats in the test valve, and across the industry in field deployment. Many successes have been documented, after all other attempts to seal the valve with other sealant products have failed.

CASE STUDIES

BOL Britannia Operator Ltd North Sea

- 701 used to obtain zero LOR isolations on flowlines for valve change outs.

ADMA (Abu Dhabi Marine Operating Co)

- 701 used to ensure wells have integral barriers for intervention, and reduce risk ranking.

PDO (Oman)

- 701 used in Steam Injection Tree leaking valves, to gain integral barriers, permitting wireline intervention for tree change-out.

PDO (Oman)

- 701-L success rate in achieving XT valve isolations in low pressure production and steam injection wells.

Saudi Aramco - 701 used to stop severe leakage in wellhead master valve.

Market Leading Sealing Performance

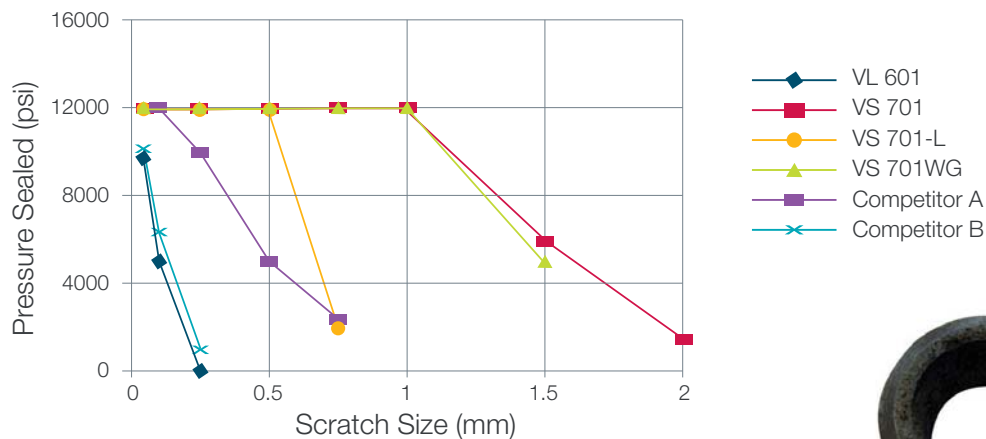

Product	Temperature Range °F
Valve Sealant 701	0 to 350
Valve Sealant 701-L	0 to 350
Valve Sealant 701 WG	-40 to 300
Valve Sealant 701-L WG	-40 to 300



RS CLARE PREMIUM VALVE LUBRICANTS AND SEALANTS ARE USED TO LUBRICATE GATE VALVES INSTALLED IN A LARGE RANGE OF OILFIELD PRESSURE CONTROL EQUIPMENT FOR:

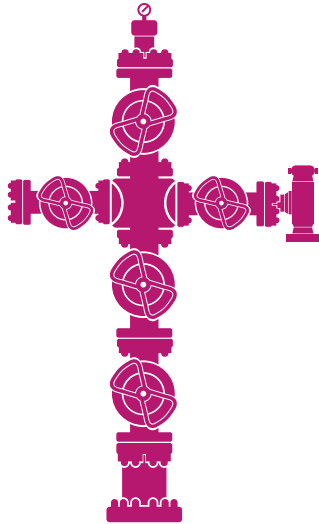

PRODUCTION OPERATIONS

The initial cost of Valve Lubricant 601 is far outweighed by the reduction in lost production.

The impact of poorly-maintained xmas tree valves on overall well integrity is significant. Leaking and non-functioning valves can lead to loss of well control. By performing regular preventative maintenance with a high performance lubricant, operators can ensure their valves perform reliably, long-term.

Across the world, both International E&P Operators and National Oil Companies have found that by standardising on Valve Lubricant 601, failure rates drop and huge cost savings are achieved.

WELL TESTING

Specialist lubricants for both gate valves and plug valves.

Surface test trees, sand filters, flow manifolds, separators - equipment that all contains valves subject to challenging conditions. High flow, aggressive chemicals and high solids all threaten the integrity of these valves, which must seal in order to obtain accurate well pressure data. The key to the success of RS Clare's valve lubricants is that they stay in the valve continuously protecting parts and blocking the build-up of sand.

Adopting RS Clare's valve lubricants over standard service grease will ensure a reduction in spare parts consumption.

WELL INTERVENTION AND WORKOVERS

When planning an intervention job, where integral well barriers will be required, ensure you have both Valve Lubricant 601 and Valve Sealant 701 and a suitable RS Clare spec pump system available **before you start the job**.

The significant performance success of Valve Sealant 701 has led a to a major IOC implementing a formal technical procedure for establishing well barrier integrity using Valve Sealant 701. In addition, a major valve OEM has classed the product as an important valve sealing tool to have available for all wellhead workover jobs, where a leaking valve may be encountered.



A large offshore oil rig is shown in the background, with several support vessels nearby. The rig is a complex structure with multiple levels and tall derrick-like towers. The background is a clear blue sky and sea.

MAXIMUM OPERATIONAL PROTECTION

STANDARDISE ON ONE GATE VALVE LUBRICANT

DRILLING AND COMPLETIONS

Used on drilling rigs from the North Sea to the Gulf of Mexico and from the Persian Gulf to Sakhalin, RS Clare's products are making the offshore environment a safer place.

Gate valves are installed on the BOP, the standpipe manifold and the choke and kill manifold - critical equipment that must function should the well need to be shut in. Valve Lubricant 601 will remain inside the valve between maintenance jobs, continuing to protect the metal sealing surfaces throughout the drilling job. The high pressures experienced in the drilling environment will not displace these highly viscous and dense greases. And throughout the entire drilling and completions process, the wide range of chemicals used will not wash out or degrade any of our premium products.

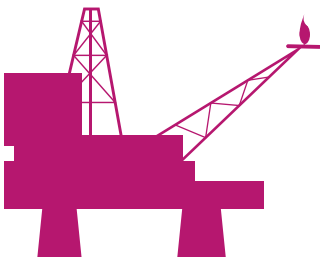

HYDRAULIC FRACTURING

The performance of RS Clare products during frack operations can generate significant cost savings.

Gate valves operating under the severe conditions of high pressure, sand flow and corrosive chemicals are prone to failure. Operators and service companies are faced with a serious time cost element when trying to keep the frack tree and manifold valves functioning.

RS Clare valve lubricants have been proven in frack jobs to be able to remain in the valve cavity, creating a barrier to the ingress of material, thus providing better protection to the valve's internals.

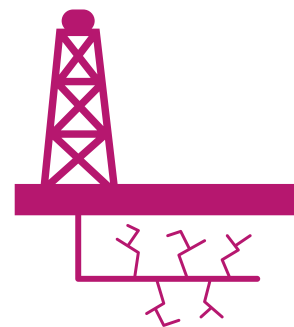

Visit our website to find out how adopting RS Clare lubricants can help you cut costs in many other application areas, including processing facilities, cyclic steam injection, decommissioning and P&A.

THE WHOLE PACKAGE

INNOVATIVE NEW SOLUTIONS FOR MULTIPLE VALVE TYPES, BUILDING ON THE RENOWNED SUCCESS OF VALVE LUBRICANT 601

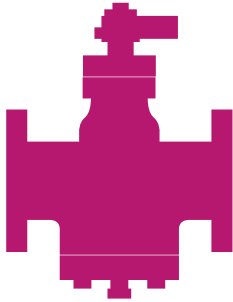

PLUG VALVE LUBRICATION

These compact shut-off valves, used in a wide range of production and process flow equipment, need a high quality grease to provide:

- An integral sealing and corrosion preventative film
- A smooth, controlled actuation over extended maintenance periods.

At RS Clare we have developed a unique technology that ensures the grease stays intact and protects the sealing faces of the valve body and plug, even under high pressure flow of water or corrosive well fluids.

BALL VALVE LUBRICATION

RS Clare has had extensive field experience of sealing leaks in ball valves with both Valve Lubricant 601 and Valve Sealant 701. In addition we offer specific lubricants designed for general maintenance of ball valves in hydrocarbon service. Retaining the technical qualities that our products are known for, whilst ensuring the sensitive valve parts will function correctly and achieve a seal.

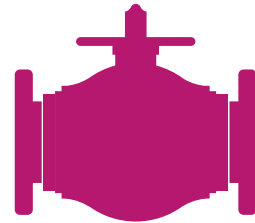

If you are interested in improving your ball or plug valve performance please visit our website and contact us to discuss trialling our products: www.rsclare.com/oil-gas

GREASE INJECTION EQUIPMENT

RS Clare's premium valve lubricants are adhesive, viscous greases designed for severe operational service conditions. In conjunction with partners, we have developed a streamlined range of high pressure pump equipment suited to handling our heavy duty products. These pumps not only have exceptionally high pressure and flow rates, they also come with bespoke stroke counters to accurately monitor and record how much grease is being injected in the valve.

OUR CORE RANGE OF PUMPS

Pump	Application
High Pressure Hand Gun	This positive prime pump can develop up to 15,000 psi and delivers RS Clare greases and sealants from cartridges - fitted with safe-vent and GBH couplers
RS Clare Spec Alemite 70:1 Pump System	Portable pump system for injecting Valve Lubricant 601 from 18kg pails
Stroke Counter Kits	Fitted to RS Clare pump systems for monitoring fill volumes
RS Clare Spec Alemite Bucket Pump	For injecting 601 Valve Cleaner up to 5,000 psi
ETD Sealant Pump System	10,000 psi, 100:1 ratio heavy duty pump for injecting Valve Lubricant 601 and Valve Sealant 701 at the highest flow rates

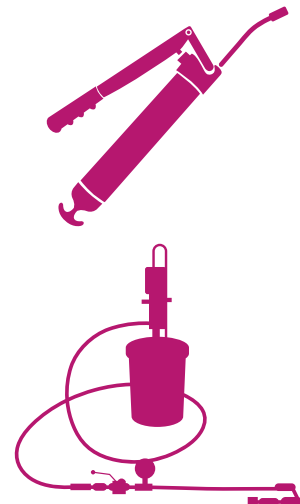

For more information please visit our website: www.rsclare.com/pump-equipment



WIRELINER FLUIDS

AT THE FOREFRONT OF ENVIRONMENTALLY
FRIENDLY LUBRICANTS

9

WIRELINER FLUIDS ARE USED TO CONTROL WELL PRESSURE DURING BRAIDED WIRELINER INTERVENTION OPERATIONS.

Developed from hydrocarbon resistant synthetic base oils with controlled viscosity profiles, these fluids create a dynamic seal against the moving wire during these critical operations.

Extensive testing of our V-series Wireline Fluids has proven the range to provide outstanding sealing performance and excellent oxidation and corrosion resistance.

V500 is a fully synthetic HOCNF certified Yellow Category fluid. This means it conforms to the Norwegian requirements for biodegradability, and passes the biotoxicity test.

V300RLWI (Riserless Light Well Intervention) is also a HOCNF certified Yellow category fluid. It was developed in association with a leading Subsea Intervention Equipment Manufacturer and is also suitable for low temperature applications.

V1000 offers excellent corrosion protection in H₂S environments and is frequently used with in slickline operations to enhance the service life of the wire and provide protection both running into the well and later when spooled.

WORLD LEADERS IN VALVE INTEGRITY



KEY



Agent or Distributor



Technical Sales Office

INNOVATION AND SUPPORT SERVICES

Our technical approach to solving customers' problems means that we have gained business globally with National and International Operators and Service Companies. We now have one of the industry's largest technical teams focussed on grease R&D, with a combined 215 years' experience in lubricant chemistry. We have long history of developing products specific to the challenges faced by our customers. If you have a problem that needs solving, our team are ready for the challenge.

Our manufacturing and research centre is head quartered in Liverpool, UK and we have technical sales staff in the UAE, Singapore and Houston. We are supported by a team of agents and distributors covering many parts of the world and expanding.

See our website to contact your local supplier: www.rsclare.com/oil-gas

Be it ISO 9001 or ISO 14001, we at RS Clare believe in the pursuit of excellence and endeavour to strive for high standards in all that we do.



TRIBOLOGY KNOWLEDGE SESSIONS

RS Clare is at the forefront of lubricant technology and can provide crucial understanding for front-line engineers.

We offer tailor made training courses to educate engineers on lubrication and tribology - the science of friction and wear. Delivered by our technical experts, the courses provide delegates with a sound background on lubricant chemistry, standard lubricant tests and grease applications relevant to wellhead valve integrity.

Talk to us about having a seminar delivered at your location: www.rsclare.com/tribology-knowledge-sessions

LEARN THE RIGHT APPROACH TO LUBRICATING YOUR CRITICAL EQUIPMENT

There are many opportunities to question our team on the technical issues faced during your wellhead valve maintenance work. RS Clare present papers at global symposiums and participate in SPE seminars. Our industry experts are on hand to help you make the right decisions in lubrication and maintenance.

RS Clare & Co Ltd

Stanhope Street
Liverpool L8 5RQ
UNITED KINGDOM

t. +44 (0)151 709 2902
w. www.rsclare.com
e. oilandgas@rsclare.co.uk

ISO 9001
ISO 14001
ISO TS 16949



RS Clare & Co Ltd

Innovation since 1748